

THE POST MODERN COLLECTION

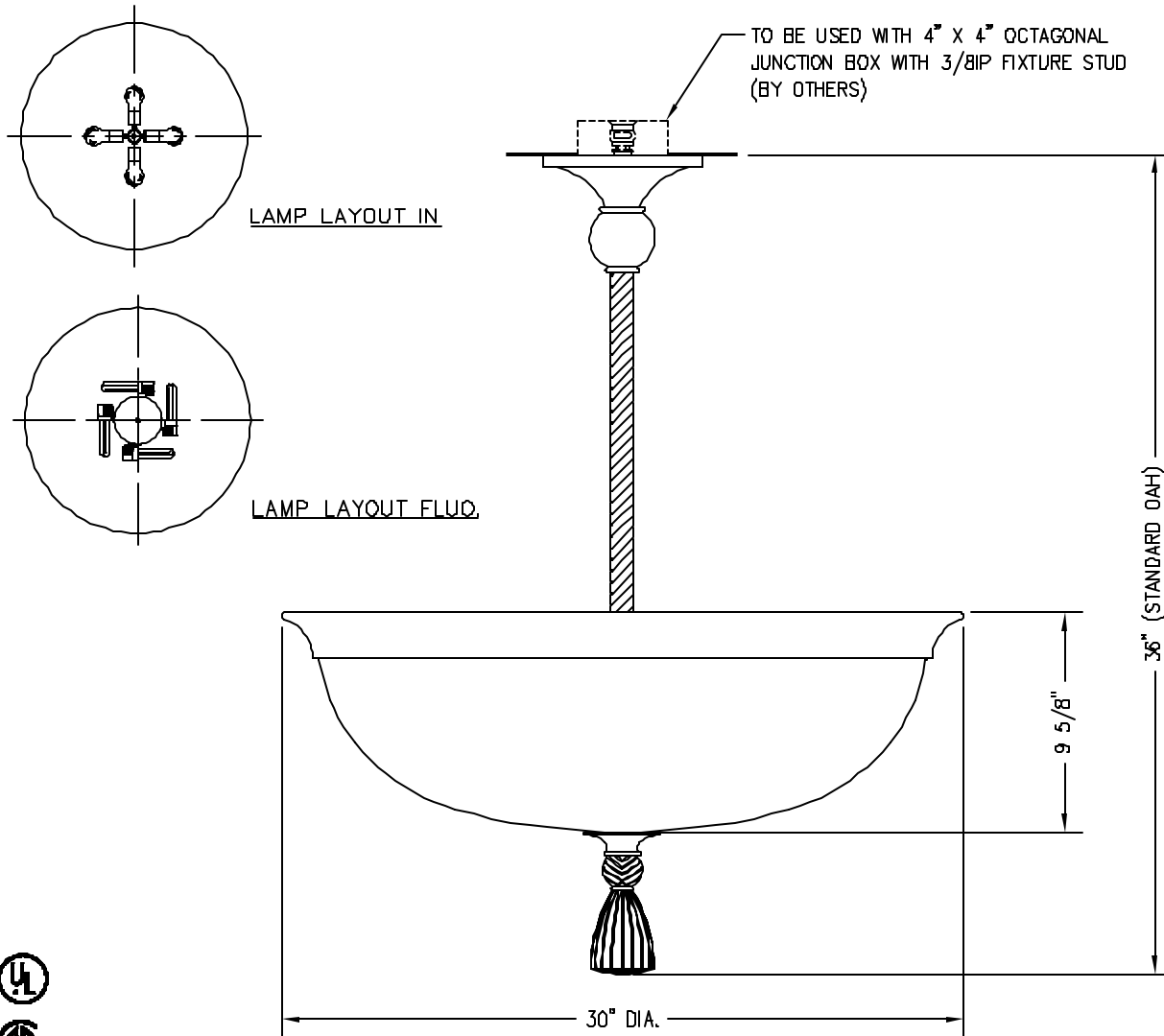

© BALDINGER ARCHITECTURAL LIGHTING, INC.

FIXTURE WEIGHT 32 LBS.

PURCHASER: _____ DATE: _____

JOB NAME: _____ TYPE: _____ QUANTITY: _____

METAL FINISHES

- ANTIQUE BRASS
- POLISHED BRASS
- SATIN BRASS
- POLISHED CHROME
- SATIN CHROME
- POLISHED NICKEL
- SATIN NICKEL
- OTHER _____

DIFFUSERS

- WHITE FAUX ALABASTER
- BEIGE FAUX ALABASTER
- WHITE ACRYLIC FROSTED
- CLEAR ACRYLIC FROSTED
- OTHER _____

LAMPING

- (4) 60W A-19 (120V only)
- (4) CFQ 18W (see below)
- OTHER _____

VOLTAGE

- 120V
- 277V
- OTHER _____

BALDINGER

BALDINGER ARCHITECTURAL LIGHTING INC
 19-02 STEINWAY STREET, ASTORIA, NEW YORK 11105
 TEL. (718) 204-5700 FAX. (718) 721-4986

TASSEL
RS28270/30