

THE REGH COLLECTION

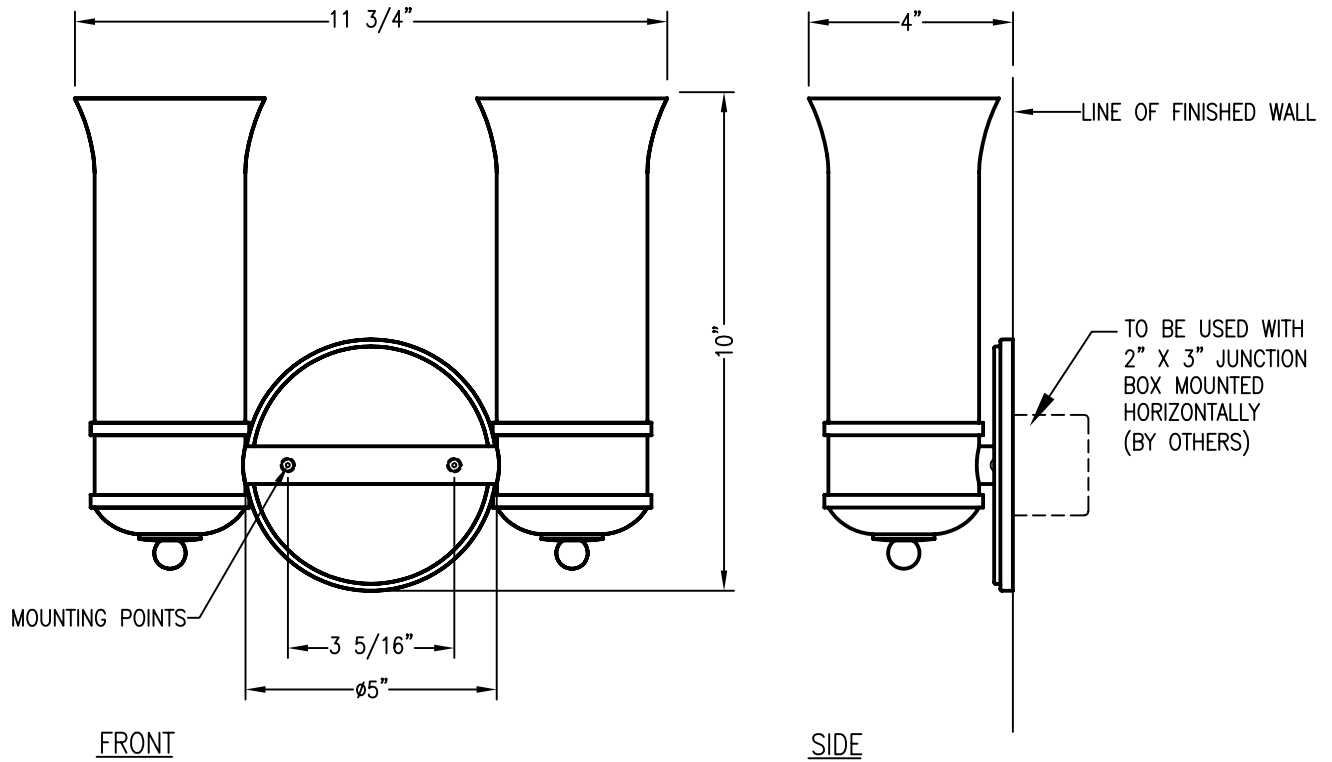

© BALDINGER ARCHITECTURAL LIGHTING, INC.

FIXTURE WEIGHT: 7 LBS

PURCHASER: _____ DATE: 06/07/05

JOB NAME: _____ TYPE: _____ QUANTITY: _____

METAL FINISHES

- POLISHED BRASS
- SATIN BRASS
- ANTIQUE BRASS
- POLISHED NICKEL
- SATIN NICKEL
- OTHER _____

DIFFUSERS

- BEIGE FAUX ALABASTER
- WHITE FAUX ALABASTER
- WHITE CASED GLASS W/ CLEAR INCISED LINE
- CLEAR FROSTED GLASS
- OTHER _____

LAMPING

- (2) CFQ 13W (120V only)
- (1) 60W BT-15* (120V only)
- OTHER _____

*BT-15 IS A PHILLIPS EXCLUSIVE LAMP

VOLTAGE

- 120V
- 277V
- OTHER _____

JOB #:

BALDINGER

BALDINGER ARCHITECTURAL LIGHTING INC
19-02 STEINWAY STREET, ASTORIA, NEW YORK 11105
TEL. (718) 204-5700 FAX. (718) 721-4986

UPTON/WS
RA30655